

BNC系列产品是按照美军标MIL-C-39012/16-24研制生产的一种卡口式射频同轴连接器。可与国际同系列产品互换。它具有连接迅速、接触可靠等特点，广泛地应用于无线电设备和电子仪器中连接射频同轴电缆，本产品执行标准GB1315。特性阻抗为50Ω、75Ω两种。

Series BNC RF.Coaxial connectors.Which have the bayonet structure coupling mating and developed according to MIL-C-39012/16-24, They can be inter-changeable with the same-type connectors of abroad, engaged and disengaged rapidly ,used to connect coaxial cables in radio equipment and instruments. They accord with the GB1315 specifications. There are 50Ω and 75Ω characteristic impedance two models.

主要技术特性		KEY PERFORMANCE	
温度范围 Temperature range	-55~+165℃	绝缘电阻 Insulation resistance	≥5000MΩ
特性阻抗 Characteristic Impedance	50Ω 75Ω	耐压 Dielectric Withstanding Voltage	1500V(rms)
频率范围 Frequency range	50Ω 0~4GHz 75Ω 0~1GHz	电压驻波比 VSWR	≤1.30
工作电压 Voltage rating	500V(rms)	分离力 Disengage force	≥0.6N
接触电阻 Contact resistance	中心导体 Center conductor	≤0.002Ω	寿命 Durability
	外导体 Outer conductor	≤0.0002Ω	
			500 Cycles

### 头部配合尺寸

### INTERFACE MATING DIMENSIONS

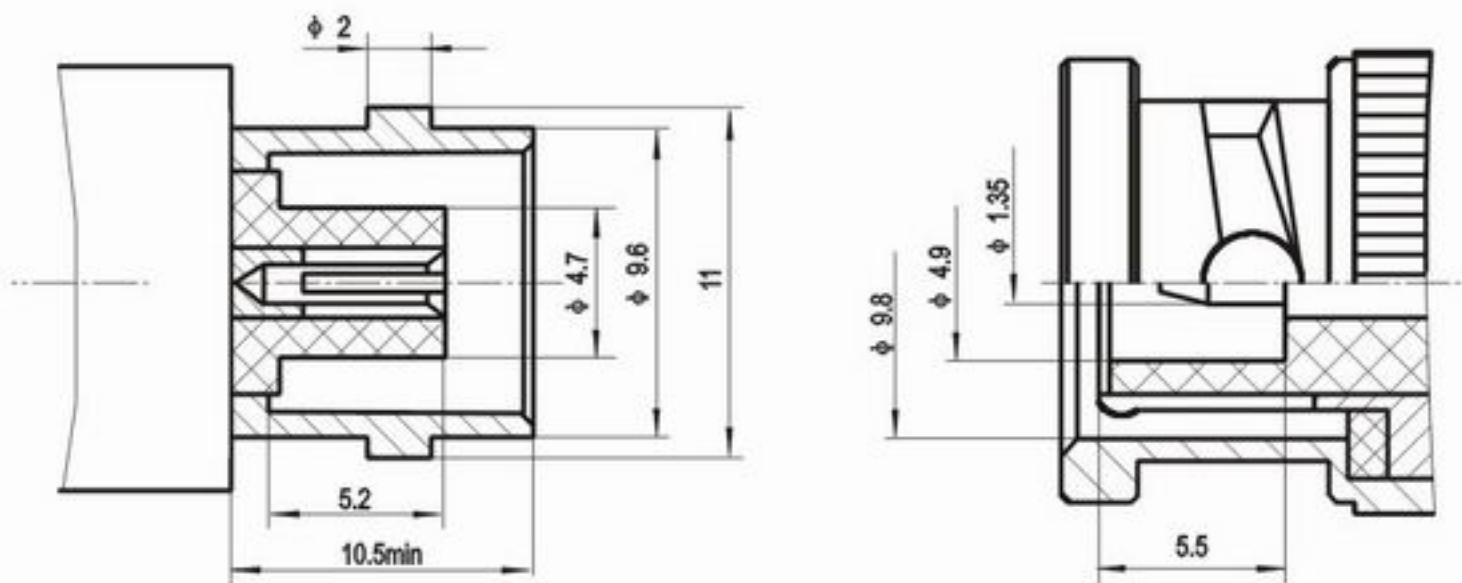

# BNC

系列射频同轴连接器  
SERIES BNC COAXIAL CONNECTORS

SRT 升瑞科技  
SUNRISE-TECH

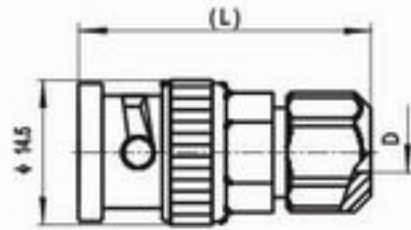

电缆剥线尺寸  
Cable stripping dimensions

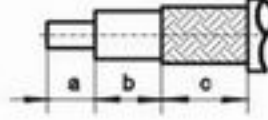

Type	D	L	a	b	c	Cable type
BNC-J3	φ 3.1	31.1	5.5	0.7	7	SFF-50-1.5-1 SYV-50-2-1
BNC-J4	φ 4.2	31.1	5.5	0.7	7	SFF-50-2-2 SYV-50-2-2
BNC-J5	φ 5.2	31.1	5.5	0.7	7	SYV-50-3
BNC-J12	φ 5.2	35	7	1	8	SYV-75-3
BNC-J13	φ 7.4	35	7	1	8	SYV-75-5-1 SYV-75-5-2

BNC-J3 等

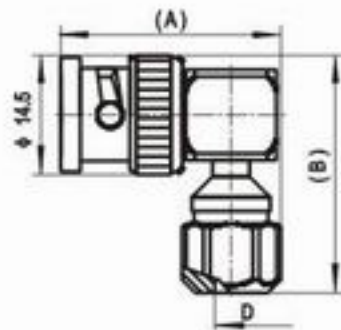

电缆剥线尺寸  
Cable stripping dimensions

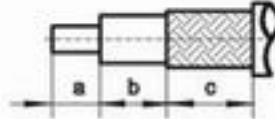

Type	D	A	B	a	b	c	Cable type
BNC-JW3	φ 3.1	26	27.4	3.4	8.4	2	SFF-50-1.5-1 SYV-50-2-1
BNC-JW4	φ 4.2	26	27.4	3.4	8.4	2	SFF-50-2-2 SYV-50-2-2
BNC-JW5	φ 5.2	26	27.4	3.4	8.4	2	SYV-50-3
BNC-JW12	φ 5.2	28	35	3.4	8.4	2	SYV-75-3

BNC-JW3 等

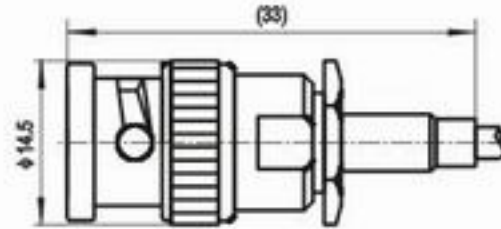

电缆剥线尺寸  
Cable stripping dimensions

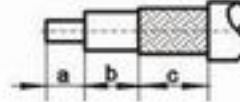

Type	a	b	c	Cable type
BNC-J2Y	2.5	10.5	3.5	SFF-50-1 SYV-50-1
BNC-J3Y	2.5	10.5	3.5	SFF-50-1.5-1 SYV-50-2-1

BNC-J2Y 等

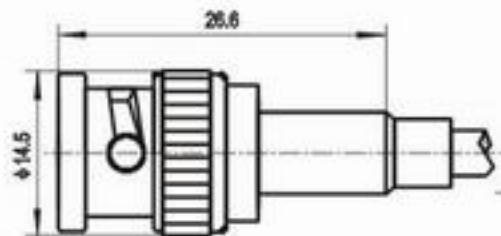

电缆剥线尺寸  
Cable stripping dimensions

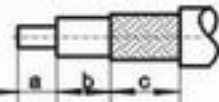

Type	a	b	c	Cable type
BNC-J4Y	3.8	4	9.5	SFF-50-2-2, SYV-50-2-2
BNC-J5Y	3.8	4	9.5	SYV-50-3

BNC-J4Y 等

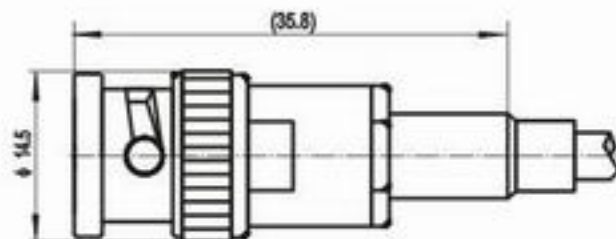

电缆剥线尺寸  
Cable stripping dimensions

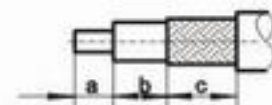

Type	a	b	c	Cable type
BNC-J12Y	7.3	11.1	10	SYV-75-3

BNC-J12Y

# BNC

系列射频同轴连接器  
SERIES BNC COAXIAL CONNECTORS

SRT 升瑞科技  
SUNRISE-TECH



BNC-JW3Y

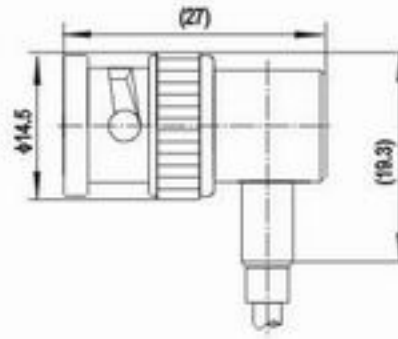

电缆剥线尺寸  
Cable stripping dimensions

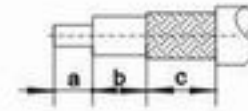

Type	a	b	c	Cable type
BNC-JW3Y	3.4	2.9	9.5	SFF-50-1.5-1、SYV-50-2-1



BNC-JW4Y 等

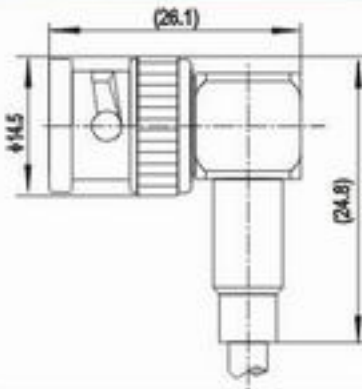

电缆剥线尺寸  
Cable stripping dimensions

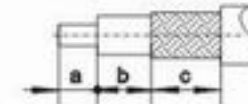

Type	a	b	c	Cable type
BNC-JW4Y	3.4	2.9	9.5	SFF-50-2-2、SYV-50-2-2
BNC-JW6Y	3.4	2.9	9.5	SYV-50-3



BNC-50JY

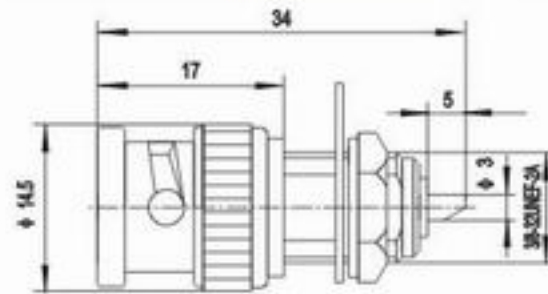

安装开孔尺寸  
Mounting hole

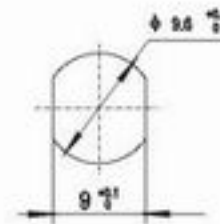

BNC-50KY

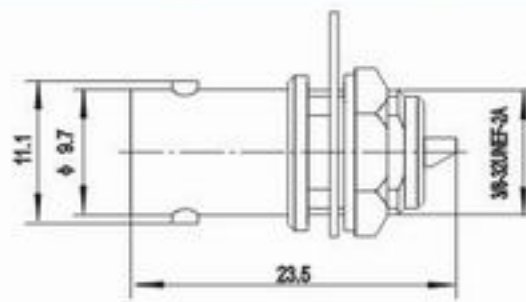

安装开孔尺寸  
Mounting hole

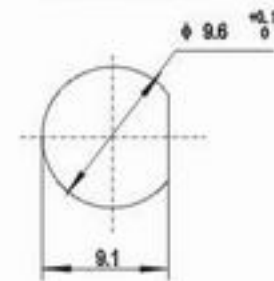

BNC-50KF 等

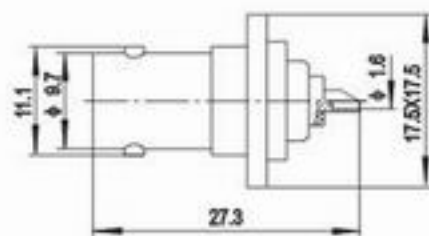

安装开孔尺寸  
Mounting hole

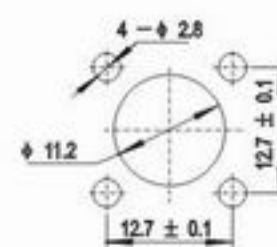

# BNC

系列射频同轴连接器  
SERIES BNC COAXIAL CONNECTORS

SRT 升瑞科技  
SUNRISE-TECH



BNC-KY3

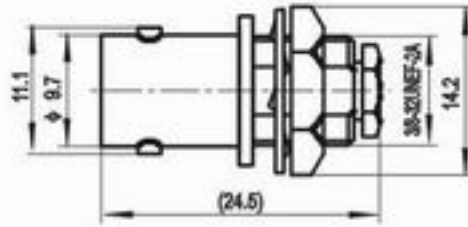

安装开孔尺寸  
Mounting hole

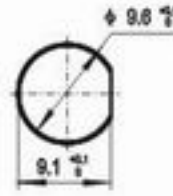

电缆剥线尺寸  
Cable stripping dimensions

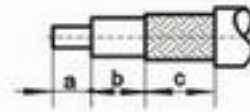

Type	a	b	c	Cable type
BNC-KY3	2.4	3.8	0.8	SFF-50-1.5-1、SYV-50-2-1



BNC-KY4 等

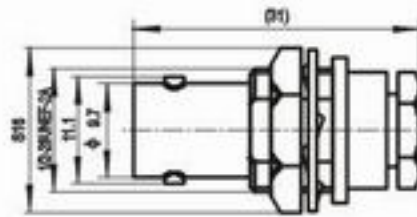

安装开孔尺寸  
Mounting hole

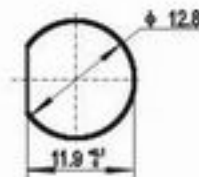

电缆剥线尺寸  
Cable stripping dimensions

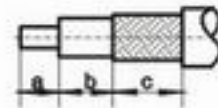

Type	a	b	c	Cable type
BNC-KY4	5.5	1	6.3	SFF-50-2-2、SYV-50-2-2
BNC-KY5	5.5	1	6.3	SYV-50-3



BNC-KHD

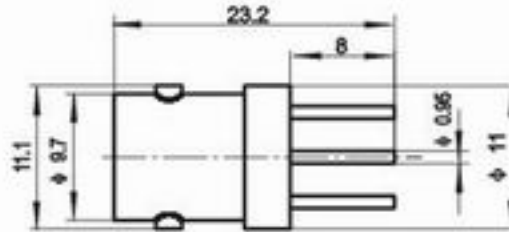

安装开孔尺寸  
Mounting hole

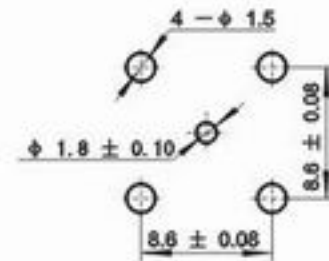

BNC-KF3

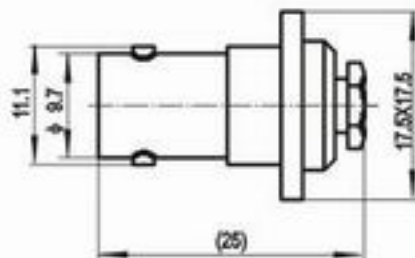

安装开孔尺寸  
Mounting hole

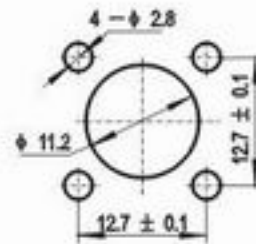

电缆剥线尺寸  
Cable stripping dimensions

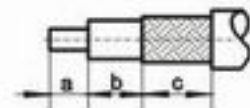

Type	a	b	c	Cable type
BNC-KF3	5	0.7	7	SFF-50-1.5-1、SYV-50-2-1



BNC-KF4 等

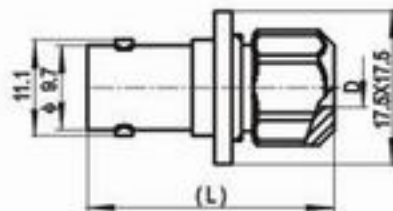

安装开孔尺寸  
Mounting hole

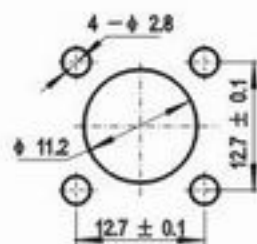

电缆剥线尺寸  
Cable stripping dimensions

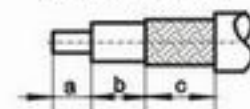

Type	D	L	a	b	c	Cable type
BNC-KF4	φ4.2	29	5	0.7	7	SFF-50-2-2、SYV-50-2-2
BNC-KF5	φ5.2	29	5	0.7	7	SYV-50-3
BNC-KF12	φ5.2	35	7	8	8	SYV-75-3
BNC-KF13	φ7.4	35	1	8	8	SYV-75-5-1、SYV-75-5-2

# BNC

系列射频同轴连接器  
SERIES BNC COAXIAL CONNECTORS

SRT 升瑞科技  
SUNRISE-TECH



BNC-KYA

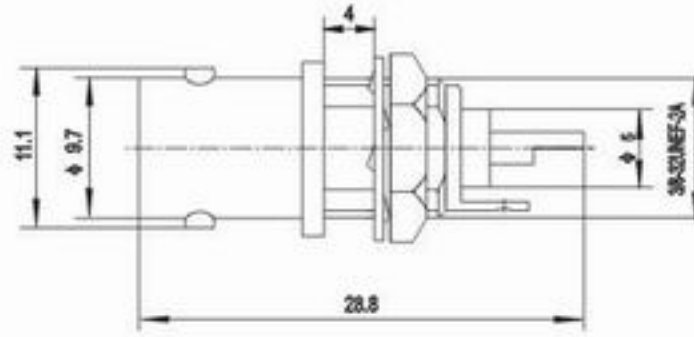

安装开孔尺寸  
Mounting hole

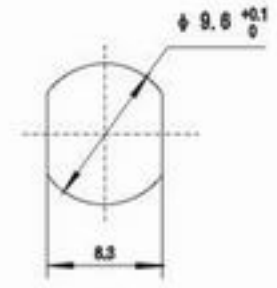

BNC-KY2Y 等

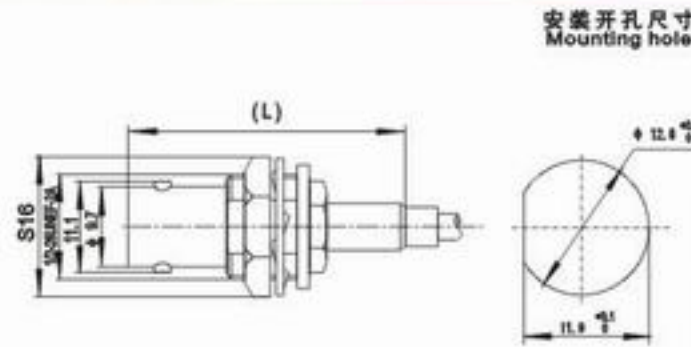

安装开孔尺寸  
Mounting hole

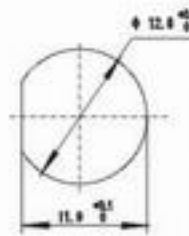

电缆剥线尺寸  
Cable stripping dimensions

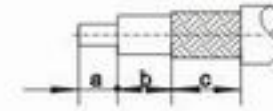

Type	L1	a	b	c	Cable type
BNC-KY2Y	30	2.4	11	5.8	SFF-50-1, SYV-50-1
BNC-KY3Y	30	2.4	11	5.8	SFF-50-1.5-1, SYV-50-2-1
BNC-KY4Y	35.5	5.5	5	4.5	SFF-50-2-2, SYV-50-2-2
BNC-KY5Y	35.5	5.5	5	4.5	SYV-50-3



BNC-50KY-3

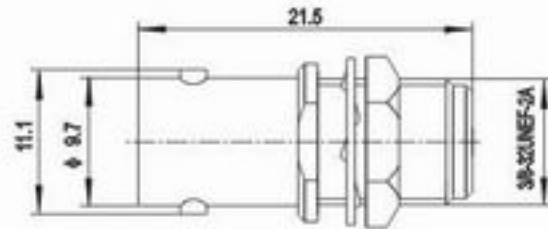

安装开孔尺寸  
Mounting hole

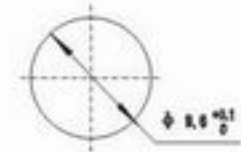

BNC(M)-KY-2

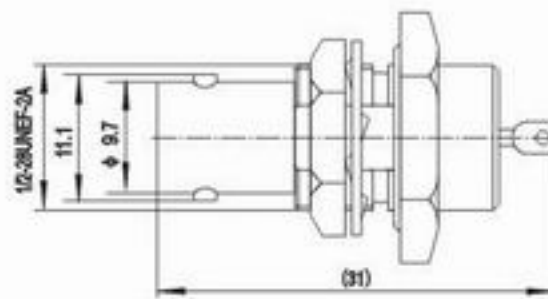

安装开孔尺寸  
Mounting hole

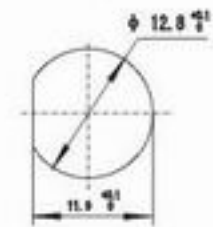

BNC-KY2

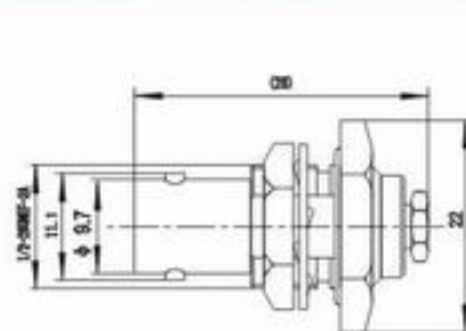

安装开孔尺寸  
Mounting hole

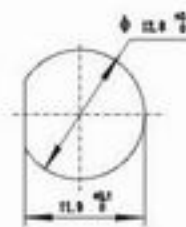

电缆剥线尺寸  
Cable stripping dimensions

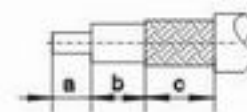

Type	a	b	c	Cable type
BNC-KY2	2.5	10.5	5.3	SFF-50-1, SYV-50-1

# BNC

系列射频同轴连接器  
SERIES BNC COAXIAL CONNECTORS

SRT 升瑞科技  
SUNRISE-TECH



BNC(S)-KY3

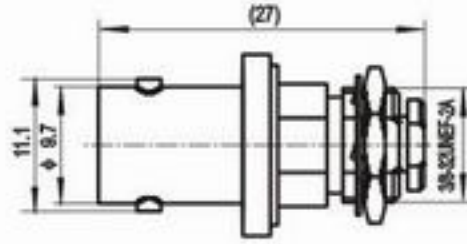

安装开孔尺寸  
Mounting hole

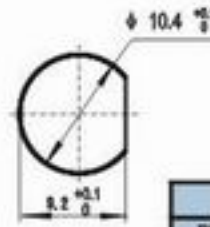

电缆剥线尺寸  
Cable stripping dimensions

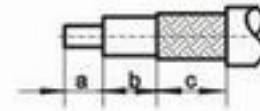

Type	a	b	c	Cable type
BNC(S)-KY3	4.2	0	6	SFF-50-1.5-1, SYV-50-2-1



BNC-KY4 等

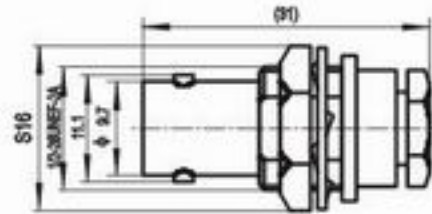

安装开孔尺寸  
Mounting hole

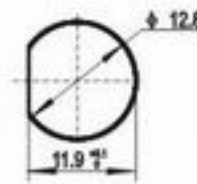

电缆剥线尺寸  
Cable stripping dimensions

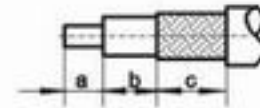

Type	a	b	c	Cable type
BNC-KY4	5.5	1	6.3	SFF-50-2-2, SYV-50-2-2
BNC-KY5	5.5	1	6.3	SYV-50-3



BNC-75J3YA

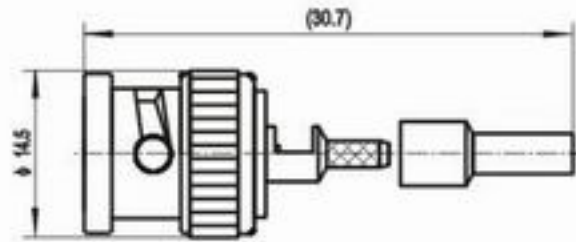

电缆剥线尺寸  
Cable stripping dimensions

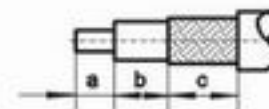

Type	a	b	c	Cable type
BNC-75J3YA	2.3	2.2	5.4	SFYZ-75-2-1



BNC-75KY

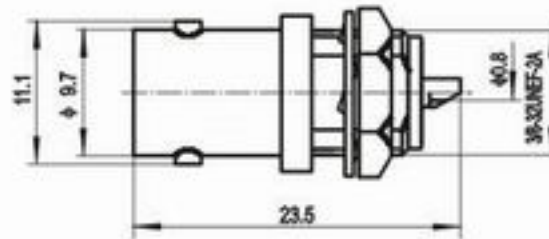

安装开孔尺寸  
Mounting hole

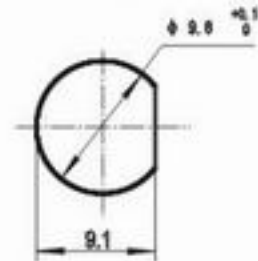

# BNC

系列射频同轴连接器  
SERIES BNC COAXIAL CONNECTORS

SRT 升瑞科技  
SUNRISE-TECH



BNC-JJ

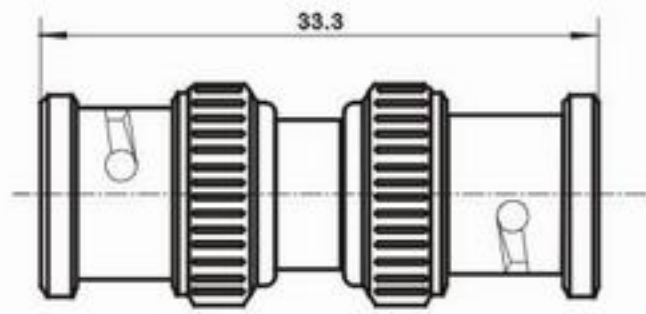

BNC-JK

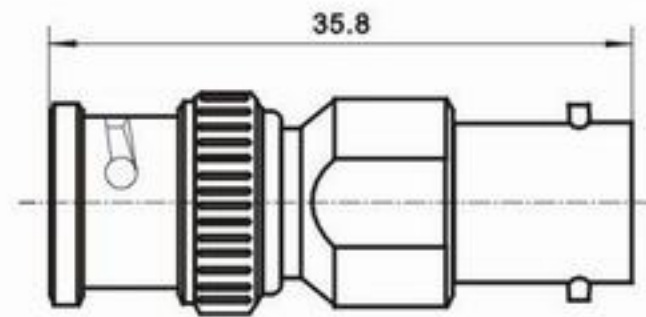

BNC-KK

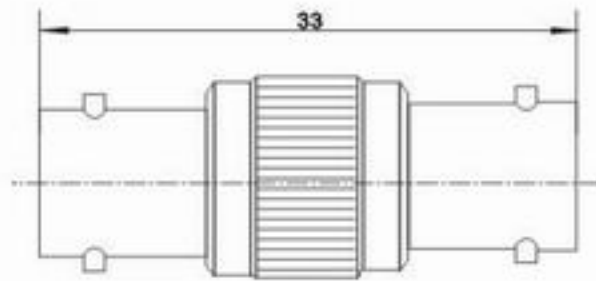

BNC-50KJK

